



# INSTALLATION GUIDELINES PERMINATOR® EVOH

PERMINATOR EVOH is a seven-layer co-extruded barrier manufactured from state-of-the-art polyethylene and EVOH resins. Designed to provide superior resistance to gas and moisture transmission, PERMINATOR EVOH is a highly resilient underslab gas/vapor barrier designed to restrict naturally occurring gases, such as radon, methane, gasoline, solvents, oils, and hydrocarbons, from migrating through the ground and into the concrete slab. PERMINATOR EVOH is furnished in rolls which are 10' (3 m) wide and 150' (45.7 m) long.

This document has been created as an addendum to the PERMINATOR EVOH technical data sheet to provide the recommended procedure to use when installing PERMINATOR EVOH in applications featuring penetrations.

## PLACEMENT

Level and tamp or roll granular base as specified. A base for a gas-reduction system may require a 4" - 6" (101.6 - 152.4 mm) gas permeable layer of clean coarse aggregate as specified by architectural or structural drawings after installation of the recommended gas collection system. In this situation, a cushion layer consisting of a non-woven geotextile fabric placed directly under PERMINATOR EVOH will help protect the barrier from damage due to possible sharp coarse aggregate.

Unroll PERMINATOR EVOH running the longest dimension parallel with the direction of the pour and pull open all folds to full width.

Extend PERMINATOR EVOH across the top of the footing and turn up against vertical wall. This will sandwich PERMINATOR EVOH between the footing, wall, and poured concrete floor. Terminate

PERMINATOR EVOH at full slab thickness and seal to wall with PERMINATOR EVOH BUTYL TAPE. Prime concrete surfaces, when necessary, and assure they are dry and clean prior to applying two-sided PERMINATOR EVOH BUTYL TAPE. Apply even and firm pressure with a rubber roller. Overlap joints a minimum of 6" (101.6 mm) and seal overlap with 4" (101.6 mm) PERMINATOR EVOH BUTYL TAPE. When used as a gas barrier, overlap joints a minimum of 12" (304.8 mm) and seal in between overlap with two-sided PERMINATOR EVOH BUTYL TAPE. Then seal with 4" (101.6 mm) PERMINATOR EVOH TAPE centered on the overlap seam.

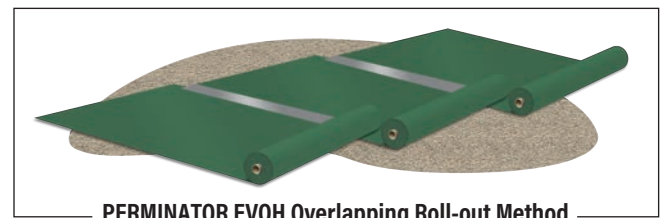

PERMINATOR EVOH Overlapping Roll-out Method

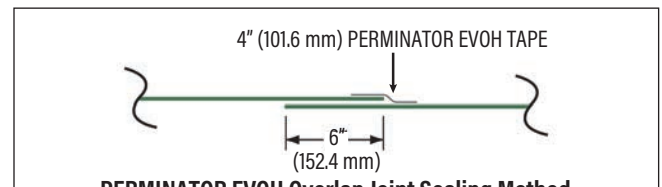

PERMINATOR EVOH Overlap Joint Sealing Method  
Vapor Retarder Applications

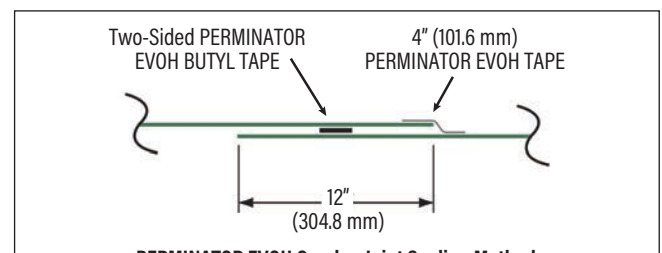

PERMINATOR EVOH Overlap Joint Sealing Method  
Gas Barrier Applications



**W. R. MEADOWS, INC.** | P.O. Box 338 | HAMPSHIRE, IL 60140-0338  
Phone: 847/214-2100 | Fax: 847/683-4544 | [www.wrmeadows.com](http://www.wrmeadows.com)



# INSTALLATION GUIDELINES PERMINATOR® EVOH

## SINGLE PENETRATION PIPE BOOT INSTALLATION

Seal around all plumbing, conduit, support columns, or other penetrations that protrude through the PERMINATOR EVOH membrane. Fabricate pipe boots from PERMINATOR EVOH excess material. Cut a square large enough to overlap 12" (304.8 mm) in all directions. Mark where to cut opening on the center of the square and cut four to eight slices about 3/8" (9.5 mm) less than the diameter of the pipe. Force the square over the pipe leaving the tightly stretched cut area around the bottom of the pipe with approximately a 1/2" (12.7 mm) of the boot material running vertically up the pipe. No more than a 1/2" (12.7 mm) of stretched boot material is recommended. Once boot is positioned, seal the perimeter to the membrane by applying two-sided PERMINATOR EVOH BUTYL TAPE in between the two layers. Secure boot down firmly over the membrane taking care not to have any large folds or creases. Use PERMINATOR EVOH TAPE to secure the boot to the pipe. Tape completely around pipe, overlapping the PERMINATOR EVOH square, to create a tight seal against the pipe. Complete the process by taping over the boot perimeter edge with PERMINATOR EVOH TAPE to create a monolithic membrane between the surface of the slab and gas/moisture sources below and at the slab perimeter.

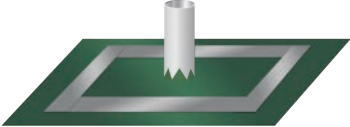
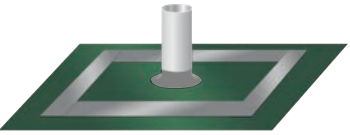
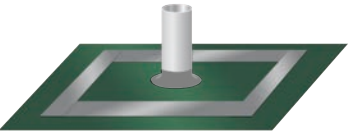
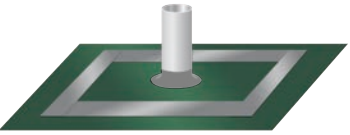
1. Cut a square of PERMINATOR EVOH barrier to extend at least 12" (304.8 mm) from the pipe in all directions. 
2. Cut four to eight slices about 3/8" (9.5 mm) less than the diameter of the pipe. 
3. Force over pipe and tape the underside boot perimeter to existing barrier with two-sided PERMINATOR EVOH BUTYL TAPE. 
4. Tape over the boot perimeter edge with PERMINATOR EVOH TAPE. 
5. Use PERMINATOR EVOH TAPE and overlap 1" (25.4 mm) at the seam. 

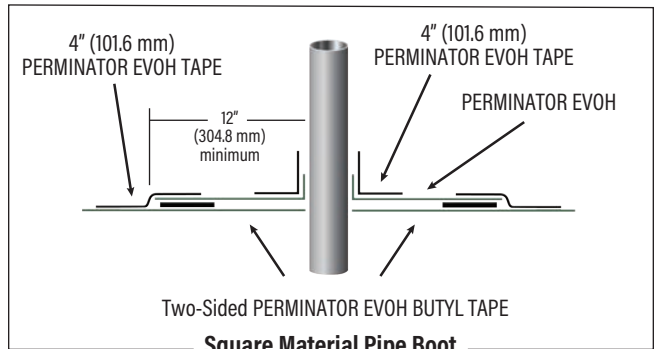

## MULTIPLE PENETRATION PIPE BOOT INSTALLATION - OPTION 1

Cut a patch large enough to overlap 12" (304.8 mm) in all directions of penetrations. Mark where to cut openings and cut four to eight slices about 3/8" (9.5 mm) less than the diameter of the penetration for each. Force patch material over penetration to achieve a tight fit and form a lip. Once patch is positioned, seal the perimeter to the membrane by





# INSTALLATION GUIDELINES PERMINATOR® EVOH

applying two-sided PERMINATOR EVOH BUTYL TAPE in between the two layers. After applying two-sided PERMINATOR EVOH BUTYL TAPE between the patch and membrane, tape around the perimeter of the penetrations and the patch with 4" (101.6 mm) PERMINATOR EVOH TAPE. For additional protection apply, REZI-WELD™ 1000 from W. R. MEADOWS around the penetrations.

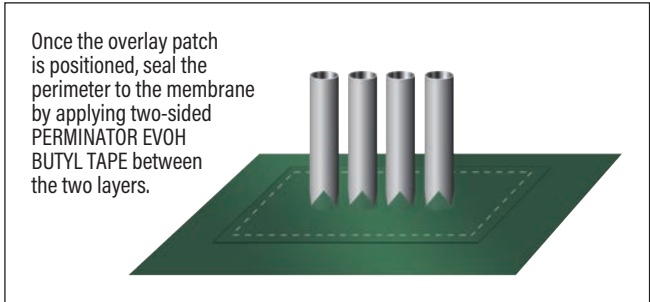
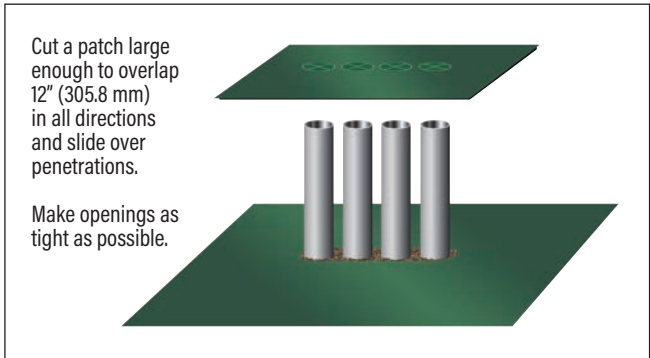
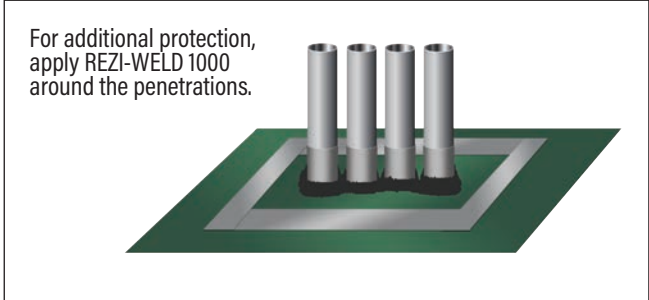
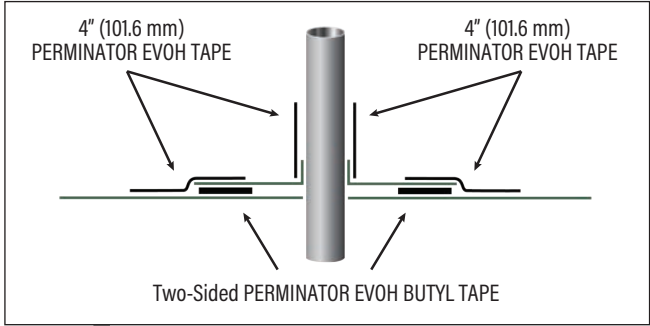
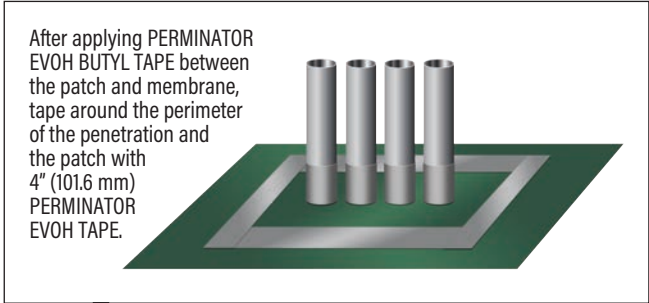

## MULTIPLE PENETRATION PIPE BOOT INSTALLATION - OPTION 2

Install PERMINATOR EVOH as closely as possible to pipe penetrations to minimize the amount of REZI-WELD 1000 necessary to seal around all penetrations. Once PERMINATOR EVOH is in place, remove soil or other particles with a dry cloth or a fine broom to allow for improved adhesion to the REZI-WELD 1000 material. Create a dam around the penetration area approximately 2" (50.8 mm) away from the pipe or other vertical penetrations by removing the release liner from the back of a 1" (25.4 mm) weather stripping foam and adhere to PERMINATOR EVOH. Form a complete circle to contain the REZI-WELD 1000 material. Once mixed, pour REZI-WELD 1000 around the pipe penetrations. If needed, a brush or a flat wooden stick can be used to direct REZI-WELD 1000 completely around penetrations creating a complete seal.





# INSTALLATION GUIDELINES PERMINATOR® EVOH

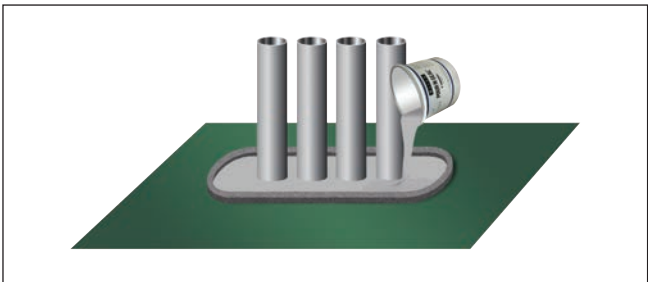
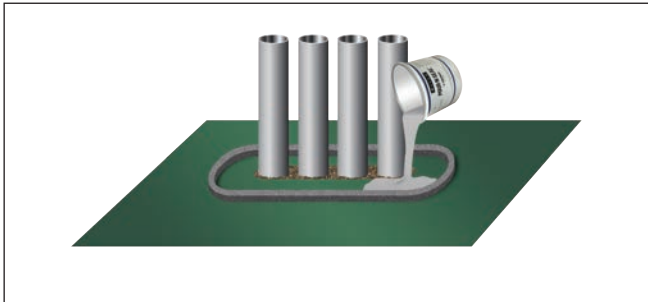
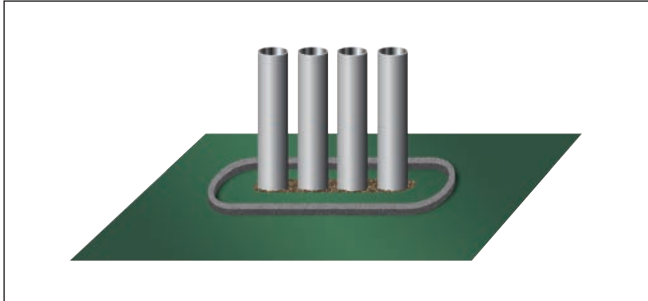

## PERMINATOR EVOH REPAIR INSTRUCTIONS

### PIPE PENETRATIONS

When installing PERMINATOR EVOH around pipe penetrations, vertical columns, electrical ducts, and other obstructions, cut the material to the nearest outside edge. This cut can be sealed with PERMINATOR EVOH TAPE by simply centering it over the cut. Once the tape is placed correctly, apply pressure to assure a complete seal. All holes or penetrations through the membrane will need to be patched with PERMINATOR EVOH TAPE.

## PERMINATOR EVOH REPAIR INSTRUCTIONS

### LARGE PATCHES

Proper installation requires all holes and openings are repaired prior to placing concrete. When patching small holes, simply use PERMINATOR EVOH TAPE.

## PERMINATOR EVOH PROTECTION

When installing reinforcing steel and utilities, in addition to the placement of concrete, take precaution to protect PERMINATOR EVOH. Carelessness during installation can damage the most puncture-resistant membrane. Sheets of plywood cushioned with geotextile fabric temporarily placed on PERMINATOR EVOH provide for additional protection in high traffic areas including concrete buggies. Use only brick-type or chair-type reinforcing





## INSTALLATION GUIDELINES PERMINATOR® EVOH

bar supports to protect PERMINATOR EVOH from puncture. Avoid driving stakes through PERMINATOR EVOH. If this cannot be avoided, each individual hole must be repaired. To avoid penetrating PERMINATOR EVOH when installing screed supports, utilize non-penetrating support. If a cushion or blotter layer is required in the design between PERMINATOR EVOH and the slab, additional care should be given if sharp crushed rock is used. Washed rock will provide less chance of damage during placement. Care must be taken to protect blotter layer from precipitation before concrete is placed.

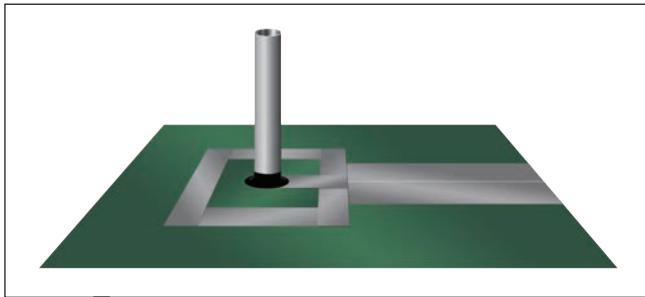

**W. R. MEADOWS, INC.** | P.O. Box 338 | HAMPSHIRE, IL 60140-0338  
Phone: 847/214-2100 | Fax: 847/683-4544 | [www.wrmeadows.com](http://www.wrmeadows.com)